



# 1-OF-10 DECODER/DRIVER OPEN-COLLECTOR

The SN54/74LS145, 1-of-10 Decoder/Driver, is designed to accept BCD inputs and provide appropriate outputs to drive 10-digit incandescent displays. All outputs remain off for all invalid binary input conditions. It is designed for use as indicator/relay drivers or as an open-collector logic circuit driver. Each of the high breakdown output transistors will sink up to 80 mA of current. Typical power dissipation is 35 mW. This device is fully compatible with all TTL families.

- Low Power Version of 54/74145
- Input Clamp Diodes Limit High Speed Termination Effects

### CONNECTION DIAGRAM DIP (TOP VIEW)

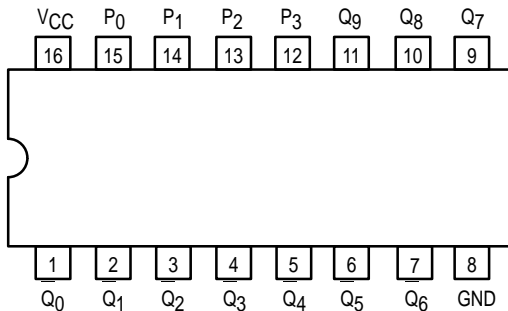

### PIN NAMES

$P_0, P_1, P_2, P_3$  BCD Inputs  
 $Q_0$  to  $Q_9$  Outputs (Note b)

### LOADING (Note a)

LOADING (Note a)	
HIGH	LOW
0.5 U.L.	0.25 U.L.
Open Collector	15 (7.5) U.L.

### NOTES:

- a) 1 TTL Unit Load (U.L.) = 40  $\mu$ A HIGH/1.6 mA LOW.  
 b) The Output LOW drive factor is 2.5 U.L. for Military (54) and 15 U.L. for Commercial (74) Temperature Ranges.

### LOGIC DIAGRAM

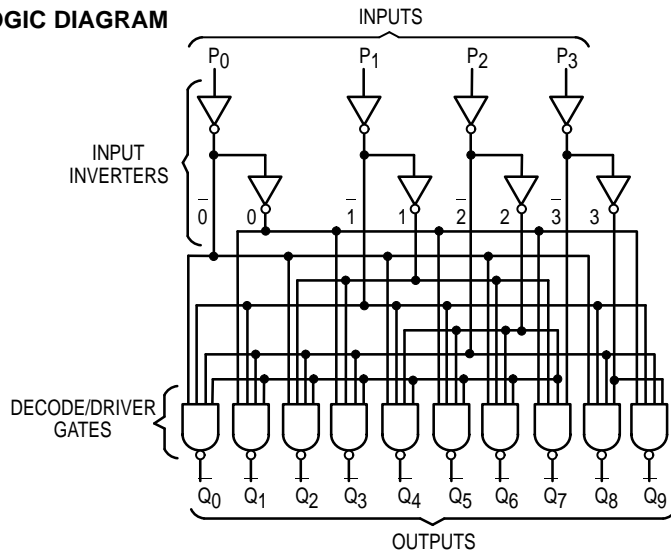

## SN54/74LS145

### 1-OF-10 DECODER/DRIVER OPEN-COLLECTOR LOW POWER SCHOTTKY

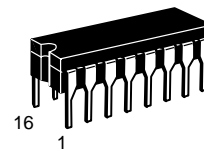

**J SUFFIX**  
 CERAMIC  
 CASE 620-09

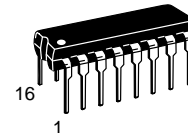

**N SUFFIX**  
 PLASTIC  
 CASE 648-08

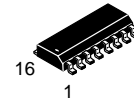

**D SUFFIX**  
 SOIC  
 CASE 751B-03

### ORDERING INFORMATION

SN54LSXXXJ Ceramic  
 SN74LSXXXN Plastic  
 SN74LSXXXD SOIC

### LOGIC SYMBOL

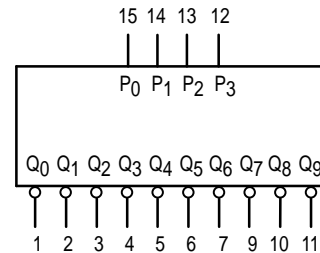

$V_{CC}$  = PIN 16  
 GND = PIN 8

# SN54/74LS145

TRUTH TABLE

INPUTS				OUTPUTS									
P <sub>3</sub>	P <sub>2</sub>	P <sub>1</sub>	P <sub>0</sub>	Q <sub>0</sub>	Q <sub>1</sub>	Q <sub>2</sub>	Q <sub>3</sub>	Q <sub>4</sub>	Q <sub>5</sub>	Q <sub>6</sub>	Q <sub>7</sub>	Q <sub>8</sub>	Q <sub>9</sub>
L	L	L	L	L	H	H	H	H	H	H	H	H	H
L	L	L	H	H	L	H	H	H	H	H	H	H	H
L	L	H	L	H	H	L	H	H	H	H	H	H	H
L	L	H	H	H	H	H	L	H	H	H	H	H	H
L	H	L	L	H	H	H	H	L	H	H	H	H	H
L	H	L	H	H	H	H	H	H	L	H	H	H	H
L	H	H	L	H	H	H	H	H	H	L	H	H	H
L	H	H	H	H	H	H	H	H	H	H	L	H	H
H	L	L	L	H	H	H	H	H	H	H	H	L	H
H	L	L	H	H	H	H	H	H	H	H	H	H	L
H	L	H	L	H	H	H	H	H	H	H	H	H	H
H	L	H	H	H	H	H	H	H	H	H	H	H	H
H	H	L	L	H	H	H	H	H	H	H	H	H	H
H	H	L	H	H	H	H	H	H	H	H	H	H	H
H	H	H	L	H	H	H	H	H	H	H	H	H	H
H	H	H	H	H	H	H	H	H	H	H	H	H	H

H = HIGH Voltage Level  
L = LOW Voltage Level

## GUARANTEED OPERATING RANGES

Symbol	Parameter		Min	Typ	Max	Unit
V <sub>CC</sub>	Supply Voltage	54 74	4.5 4.75	5.0 5.0	5.5 5.25	V
T <sub>A</sub>	Operating Ambient Temperature Range	54 74	-55 0	25 25	125 70	°C
V <sub>OH</sub>	Output Voltage — High	54, 74			15	V
I <sub>OL</sub>	Output Current — Low	54 74			12 24	mA

# SN54/74LS145

## DC CHARACTERISTICS OVER OPERATING TEMPERATURE RANGE (unless otherwise specified)

Symbol	Parameter	Limits			Unit	Test Conditions
		Min	Typ	Max		
$V_{IH}$	Input HIGH Voltage	2.0			V	Guaranteed Input HIGH Voltage for All Inputs
$V_{IL}$	Input LOW Voltage	54		0.7	V	Guaranteed Input LOW Voltage for All Inputs
		74		0.8		
$V_{IK}$	Input Clamp Diode Voltage		-0.65	-1.5	V	$V_{CC} = \text{MIN}$ , $I_{IN} = -18 \text{ mA}$
$I_{OH}$	Output HIGH Current	54, 74		250	$\mu\text{A}$	$V_{CC} = \text{MIN}$ , $V_{OH} = \text{MAX}$
$V_{OL}$	Output LOW Voltage	54, 74	0.25	0.4	V	$V_{CC} = V_{CC} \text{ MIN}$ , $V_{IN} = V_{IL} \text{ or } V_{IH}$ per Truth Table
		74	0.35	0.5	V	
		54, 74	2.3	3.0	V	
$I_{IH}$	Input HIGH Current			20	$\mu\text{A}$	$V_{CC} = \text{MAX}$ , $V_{IN} = 2.7 \text{ V}$
				0.1	mA	$V_{CC} = \text{MAX}$ , $V_{IN} = 7.0 \text{ V}$
$I_{IL}$	Input LOW Current			-0.4	mA	$V_{CC} = \text{MAX}$ , $V_{IN} = 0.4 \text{ V}$
$I_{CC}$	Power Supply Current			13	mA	$V_{CC} = \text{MAX}$ , $V_{IN} = \text{GND}$

## AC CHARACTERISTICS ( $T_A = 25^\circ\text{C}$ )

Symbol	Parameter	Limits			Unit	Test Conditions
		Min	Typ	Max		
$t_{PHL}$ $t_{PLH}$	Propagation Delay $P_n$ Input to $Q_n$ Output			50 50	ns	$V_{CC} = 5.0 \text{ V}$ $C_L = 45 \text{ pF}$

## AC WAVEFORMS

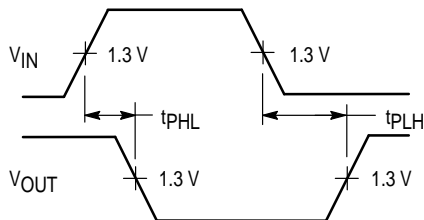

Figure 1

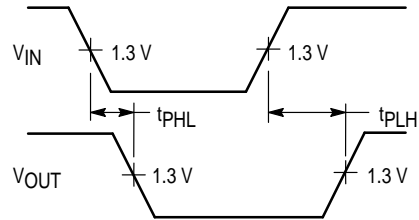

Figure 2